

## Section 5 - Application Information

### 5.1. Connection Diagrams

Kulite piezoresistive pressure transducers incorporate integral compensation elements within the transducer case except for some of the very smallest units, in which case, the compensation resistors are contained within an in-line cable module. Where there is no external compensation module, the leads (cable) may be cut off as short as necessary. Electrical connections require only that correct polarity of excitation (input) and signal (output) be observed.

### 5.2. Mounting Techniques

In order to achieve accurate measurements with any pressure transducers, it is important the pressure transducer diaphragm be allowed approximately 0.254mm (0.010 inches) radial and axial clearance within the pressure measurement volume.

**WARNING:** Any mechanical loading other than distributed fluid pressure loads will cause stress concentrations in the diaphragm and will result in erroneous data and/or possible failure of the device. It is not permitted to press on an exposed silicon diaphragm at any time. Be sure that mounting of the device does not transfer stress to the diaphragm. The case and internal designs of Kulite pressure transducers provide the maximum possible mechanical isolation, considering size limitations. Care must still be exercised when mounting. Bending moments or mechanically stressing the device will usually result in asymmetric bending of the stress sensitive diaphragm and will evidence itself as a large zero shift or highly nonlinear outputs. When mounting the pressure transducer, it is advised that the output of the unit be continually monitored for shifts or deviations of any type. Recommended mounting torques are listed on the data sheets. Consult with Kulite for recommended mounting techniques. If using epoxy or other hard potting compounds for mounting of the transducer, keep the epoxy away from direct contact with the perimeter of the diaphragm. Any contact with the diaphragm may transmit stresses from the test object directly into the diaphragm causing zero shifts, erroneous data and thermal drifts. If it is necessary to fill a void near the diaphragm, use a soft potting material such as RTV silicone rubber which will not transmit shear stress. Flat units are particularly susceptible to bending stresses as a result of their low profile. Be sure to mount these on a flat surface without bending forces.

#### 5.2.1. Strain Sensitivity

##### 5.2.1.1. Threaded Mounting Configurations

Detailed mounting dimensions and tolerances are provided on each data sheet.

Mounting dimensions with tolerances outside these specifications may cause increased ZMO, increased thermal zero shift, or seal leakage.

Avoid any stresses in front (toward the diaphragm) of the mounting threads.

When threaded configuration transducers are mounted as specified, they are highly immune to the effects of strain in the mounting structure.

##### 5.2.1.2. Cylindrical Configurations

Because of their smaller size, unthreaded cylindrical configurations (Kulite XCQ, XCL etc.) are more sensitive to case strain than threaded designs. They should always be mounted with a relatively flexible adhesive, such as Dow Coming RTV 738. Mounting detail dimensions are provided on each data sheet.

It is especially important to avoid application of adhesive near the front of the case. No stresses should be imposed on the front portion of the case.

When cylindrical configuration transducers are mounted as specified, they are highly immune to the effects of strain in the mounting structure.

#### **5.2.1.3. Thin Line Transducers (flat pack)**

Thin line transducers are designed to be mounted on the surfaces of airfoils, wings and other aerodynamic components. Transducers are typically mounted using epoxy or silicone rubber materials. If removal of the transducer without damage is desired, the selection of adhesive is very important. The housing of the transducer is very thin and can easily be damaged from bending and prying under the edge. Also solvents for the adhesive may damage the transducer interior if allowed into the pressure inlet area. Silicone RTV adhesives or wax can be used for mounting and can be cut away or removed with the application of heat to free the transducer without damage.

Another factor associated with mounting materials is their effect on the transducer when installed on structures which are subject to bending. Structural surface strains which are transmitted to the base of the transducer result in an error signal output. Kulite's design of flat pack transducers provides for base strain isolation within the assembly. However, its performance can be enhanced if additional strain isolation is provided by using soft mounting materials or by reducing the mounting area.

In addition to the effects of mounting materials on base strain sensitivity, the thickness of the structure on which the transducer is mounted affects the strain output. Thin structures such as compressor or turbine blades or an airplane skin typically bend during normal operation. This results in increased error from the base strain sensitivity of the transducer.

#### **5.2.2. Strain Measurement**

Kulite manufactures a range of semiconductor strain gauges which are available for either application by Kulite to a customer's component or can be applied by the customer. Kulite provides a Strain Gauge Manual (reference KSGM-3) which is available on request. A more recent application report on the use of Kulite strain gauges is referenced in section 9.3.9.

### **5.3. Insulation**

The case of the transducer acts as a mechanical and electrical shield for the sensing elements. It is normally electrically insulated from the elements and is not connected to the shield of the cable. The case is assumed to be grounded to the structure in which it is mounted.

Insulation resistance between all leads connected together and the transducer case or the shield is 100 megohms (minimum) at 50 volts dc.

In Kulite's original Integrated Sensor design of pressure transducers, the pressure media is in contact with the piezoresistive strain gauge elements, the metallised connections on the surface of the silicon diaphragm and the 4 or 5 gold wires connecting the diaphragm to the header. This design of transducer is commonly referred to as an "open" diaphragm design and has been used predominantly for ultra miniature units.

With all "leadless" design transducers, the gauge elements are insulated from the pressure media by the silicon diaphragm. For all oil filled isolated designs, the isolation diaphragm provides a robust barrier between the pressure media and the silicon diaphragm.

### **5.4. Cabling**

The cable which connects a transducer to its matching electronics is an important part of the overall measurement system. It must transmit the transducer signal to the associated signal conditioning equipment without distortion or introduction of noise. Cables must also not affect transducer or test specimen characteristics. Good transducer cables are as small, light and flexible as possible, considering their specific intended application.

### 5.4.1. Standard Cables

Each Kulite transducer is equipped with an integral shielded multi-conductor cable or individual lead wires, typically 30 inches long. The lead wires are colour coded per ISA standards.

Individual lead wires and the outer cable jacket are typically Teflon-insulated.

Because they are designed for maximum flexibility and micro-miniature size, these cables should be handled with care; they can be damaged if misused. They should not be stepped on, kinked, knotted, etc.

When possible, the cable should be tied down within two to three inches of the transducer. Long, unsupported lengths of cable may load the test specimen and lead to cable damage. Good housekeeping should be observed; excess cable should be neatly coiled and tied down. In humid applications, it is good practice to provide a drip loop at the transducer. It may also be advisable to seal the cable to prevent moisture from entering the cable assembly.

### 5.4.2. Splicing and Extension Cables

Leads may be spliced using good instrumentation practice. Care must be taken to minimise the resistance of the splice. The effects of cable resistance on sensitivity and the effects of RC filtering in the shielded cable must be accounted for when accurate effective sensitivity is needed.

Soldered or crimped splice and copper extension wire are preferable, to reduce the likelihood of thermoelectric generation of error voltages.

For best protection from EMI/RFI induced noise, any extension cable should be shielded. The transducer cable shield should be connected to the extension cable shield, which can then be grounded at the signal conditioner.

### 5.4.3. Loading Effects

An equivalent circuit of a piezoresistive transducer for use when considering loading effects is shown below:-

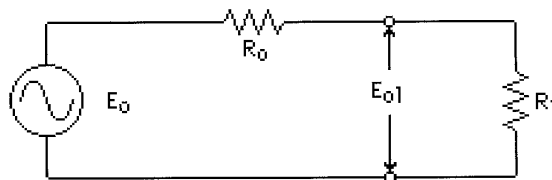

**Figure 5-1: Schematic Diagram of Loading Effects**

Where :-

$R_0$  = output resistance of the bridge including cable resistance

$E_0$  = sensitivity into an infinite load

$E_{0L}$  = loaded output sensitivity

$R_L$  = load resistance

Using the equivalent circuit above, and the output resistance supplied on the calibration document, the effect of the loading may be directly calculated:-

$$E_{0L} = E_0 \left( R_L / (R_L + R_0) \right) \quad (5.1)$$

Because the resistance of the strain gauge elements vary with temperature, output resistance must be measured at the operating temperature.

#### 5.4.4. Effects of Cable on Transducer Sensitivity

Each Kulite transducer is calibrated and supplied with a specified length of cable. When utilizing very long cables in a particular application, three effects must be noted: Excitation voltage drop, signal attenuation, and RC filtering effects.

##### 5.4.4.1. Excitation Voltage Drop

Resistance in the input (excitation) wires may significantly reduce the excitation voltage at the transducer, resulting in a loss of sensitivity. The new sensitivity ( $E_{iL}$ ) is equal to:-

$$E_{iL} = E_0 ( R_i / (R_i + 2R_{ci}) ) \quad (5.2)$$

where  $R_i$  is the input resistance of the transducer and  $R_{ci}$  is the resistance of one excitation wire.

This effect may be overcome by using remote sensing leads.

##### 5.4.4.2. Signal Attenuation

Signal attenuation also results from resistance in the output wires. This attenuation may readily be calculated from the relation:-

$$E_{oL} = E_0 ( R_L / (R_0 + R_L + 2R_{co}) ) \quad (5.3)$$

where the terms are as defined in Section 5.4.3, and  $R_{co}$  is the resistance of one output wire between transducer and load.

##### 5.4.4.3. RC Filtering

RC filtering in the shielded instrument leads may attenuate the high frequency components in the data signal. The stray and distributed capacitance present in the transducer and a short cable are such that any filtering effect is negligible. However, when long leads are connected between transducer and readout equipment, the response at higher frequencies may be significantly affected. Typical instrumentation cable will have capacitance of approximately 30 pF/ft.

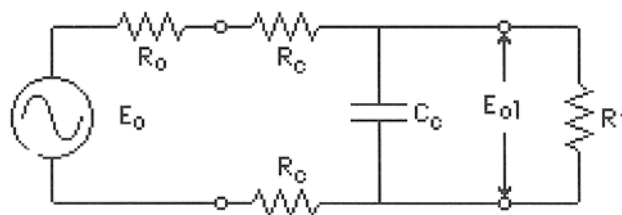

**Figure 5-2: Schematic Diagram of Simplified Transducer Circuit with Long Cable**

The -3 dB cutoff frequency for this system is:

$$f_c = 1 / 2\pi (R_{0t} + 2R_c) C_c \quad (5.4)$$

where:-

- $R_c$  = Resistance of cable
- $C_c$  = Capacitance of cable

Because the resistance and capacitance is actually distributed along the cable, the above circuit only approximates the effect of long wires. It is suggested that each 1000 feet of cable be considered as a

separate RC network. For precise measurements, line filtering action must be determined experimentally as part of the system calibration.

## 5.5 Measurement of Dynamic Pressures

In any dynamic measurement, the frequency response of the transducer and the electronics must be considered. The requirement peculiar to pressure measurement is that one must consider the fluid coupling to the transducer from the measurement point. For example, when a transducer must be placed remote from a measurement point, the response of a pressure line can severely limit the response of the measurement system. When measuring pressure oscillations in the audio frequency domain, the selection and placement of a transducer at the measurement point can be critical. In addition to the dynamic characteristics of a transducer and its placement, the results are a function of certain qualities of the fluid. These are significantly different for gases and liquids.

The summaries below review some of the fundamental considerations from the standpoint of a pressure measurement.

### 5.5.1. Acoustic and Fluid Flow Effects

#### 5.5.1.1. Acoustic Fundamentals

Sound Speed in Liquid - The speed of a compressional pulse in any homogeneous isotropic medium is:-

$$c = \sqrt{\frac{k}{\rho}} \quad (5.5)$$

where  $k$  = volume modulus  
 $\rho$  = mass density

The approximate speed of sound in two commonly used liquids:

Water = 1440 meter/sec	(4724 ft/sec)
Alcohol = 1240 meter/sec	(4068 ft/sec)

For comparative purposes the speed of sound in steel is about 5500 meter/sec (18040 ft/ sec)

#### 5.5.1.2. Sound Speed in Gas

The speed of sound in a gas is:-

$$c = \sqrt{\gamma \frac{RT}{M}} \quad (5.6)$$

where  $c$  = speed of sound in a gas  
 $\gamma$  = ratio of the two principal specific heats of the gas  
 $R$  = gas constant per mole  
 $T$  = absolute temperature  
 $M$  = molecular weight of the gas

From this equation we may conclude that the speed of sound in ideal gases depends only on the kind of gas and the temperature and is wholly independent of changes in pressure.

If we denote  $C_t$  as the speed of sound in a given gas at temperature  $T$  and by  $C_o$  the speed in the same gas at temperature  $T$  and apply the above equation, we have :-

$$C_t = C_o T / T_o \quad (5.7)$$

At 0°C, the speed of sound in dry air is 331.45 m/s (1088 ft/sec) and the speed increases about 0.6 m/s (2 ft/sec) for each degree centigrade of rise in temperature. Sound velocity increases slightly with increasing humidity.

The speed of sound in several commonly-used gases at 15°C is:

Air	= 341 meter/sec	(1119 ft/sec)
Hydrogen	= 1270 meter/sec	(4167 ft/sec)
Carbon Dioxide	= 258 meter/sec	(846 ft/sec)

### 5.5.1.3. Organ Pipe Resonance

The wavelength of the fundamental wave is equal to four times the length of the pipe for a pipe which is open at one end and closed at the other end. Resonant excitation can be produced by the fundamental frequency,  $f_n$ , and all the odd harmonics.

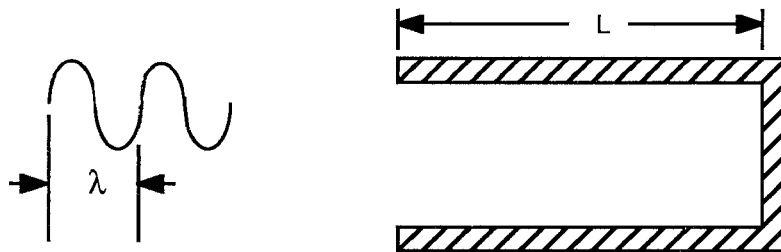

Figure 5-3: Organ Pipe Resonance

$$f_n = \frac{c}{4L}, \frac{3c}{4L}, \frac{5c}{4L} \quad (5.8)$$

$f$  = frequency  
 $c$  = speed of sound in the fluid  
 $L$  = length of pipe

If  $l$  = wavelength,

$$l = \frac{c}{f}$$

### 5.5.1.4. Cavity Resonances (Helmholtz)

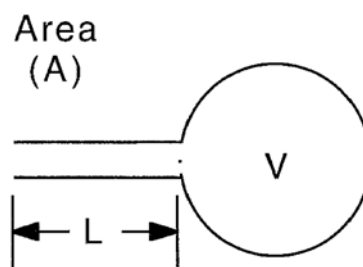

Figure 5-4: Cavity (Helmholtz) Resonances

$$f_n = \frac{c}{2\pi} \sqrt{\frac{A}{LV}}$$

where:  $c$  = speed of sound in the fluid

(5.9)

(5.10)

### 5.5.1.5. Transmitting Tube Connected to Cavity

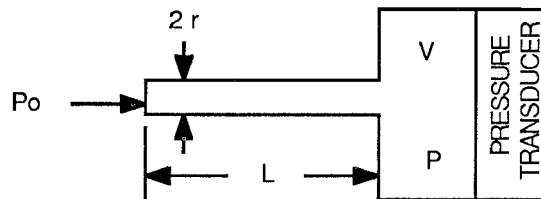

Figure 1.13, Tube and Cavity

Figure 5-5: Tube and Cavity

The natural frequency of the tube and cavity system is:-

$$f_n = \frac{1}{2\pi} \sqrt{\frac{3\pi r^2 c^2}{4LV}} \quad (5.11)$$

#### 5.5.1.6. Pressures in a Flowing Fluid

The inertia of a flowing fluid causes an impact or dynamic pressure to be generated on surfaces perpendicular to the direction of flow. This phenomenon is used in Pitot (or Pitot-static) tubes and stagnation probes to measure flow velocity.

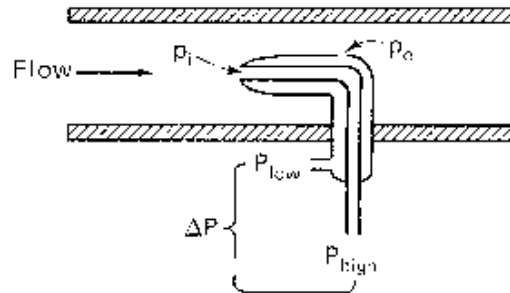

Figure 5-6: Pitot-Static Probe

Stagnation (also "total") pressure (Ps) is measured inside the open end of the tube where the gas stream has decelerated until its velocity is zero.

Static pressure (Po) is measured in the; static tube, which has holes perpendicular to the flow direction about 10 tube diameters back from the end of the tube. This is the pressure not caused by flow velocity.

Impact ("velocity") pressure is the stagnation pressure minus the static pressure (Ps- Po). It is the pressure caused by the inertial effects of the flowing fluid.

For supersonic flow, the configuration is much the same, but the shock wave around the tube does not permit direct measurement of Ps. Instead, the total pressure behind the shock wave is measured and used in a more complicated relationship to calculate the velocity.

In addition to Pitot/static tubes, many flow measurement schemes use differential pressure measurements across orifice plates, venturis, or other flow restrictions such as oil, fuel or air filters. In some applications, the normal pressure drop between two points in a system of pipes can be used as an indication of flow. Kulite have developed a Pitot/ Static probe which is commercially available and is fully reported in reference 5.3.10.

#### 5.5.1.7 Pressure Shock Wave Effects

Pitot or stagnation probes are often used to measure pressure shock waves generated by explosions, sonic booms, or lightning strokes. These shock waves are large amplitude mechanical (compression-rarefaction) waves travelling at supersonic velocities.

When energy is suddenly released into a fluid in a concentrated form, such as by a chemical or nuclear explosion, the local temperature and pressure may rise instantaneously to such high values that the fluid tends to expand at supersonic speed. When this occurs, a blast wave forms, and propagates the excess energy from the point of explosion. If the point of explosion is far from any fluid boundary, the blast wave assumes the form of an expanding spherical shock wave followed by a radially expanding fluid originating from the point of detonation.

At measurement locations near the point of explosion, the pressure wave front has an extremely fast rise time, near instantaneous. The amplitude of the wave front and subsequent reflection waves may be



extremely high. This is followed by a long period of decay, a rarefaction or expansion wave and a transition into acoustic waves. Significant pressure variations may continue for a relatively long time. Although the amplitudes are lower, sonic booms and thunderclaps generate similar short rise time, long duration pressure disturbances.

In many applications, such as explosive and shock tube tests, the expanding gases carry debris produced by the explosive, or picked up in transit.

### 5.5.2. Acoustic Limitation of a Pressure Probe

Frequency response requirements are often greater than 500 Hz for the measurement of transient total pressure in gas paths of gas turbine engines. To measure this, small pressure transducers such as the Kulite XCQ series of cylindrical ultra miniature units are placed in probes. To protect the transducer from particulate damage and to provide a more thermally benign environment it is sometimes desirable to place the transducer back from the front of the probe. (An extreme example is to measure at the end of a capillary tube.) An example of such device is shown by Figure 1.16.

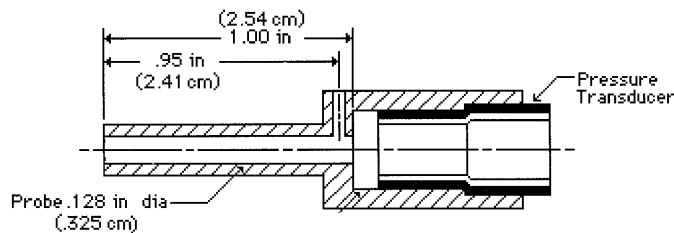

**Figure 5-7: Dynamic Pressure Probe**

Simply estimating the lowest resonance of this system by using the equations shown earlier for organ pipes or for tubing/cavity combinations results in an answer of about 3000 Hz.

Using a high frequency pressure transducer and the dimensions shown in Figure 1.16, the first resonance is close to 3000 Hz and has a high amplification factor typical of a system with low damping. This is far below the resonance frequency for the pressure transducer diaphragm, which for the Kulite XCQ-072 series of pressure transducers is typically 150 kHz for a 5 psi unit, rising to .

### 5.5.3. Dynamic Response of Transducer in Liquid System

In addition to the limitations from the acoustic characteristics of a liquid system, the mechanical characteristics of a transducer must be considered. Normally one thinks of the dynamic behaviour of a pressure transducer as being a function of its resonance frequency and damping ratio. When making measurements in liquids this oversimplifies the situation. The transducer force summing device may be considered as a spring, mass, and a damper. When this is attached to a liquid system one must effectively add liquid mass and damping to this mechanical system. When doing so the resonance frequency of the measurement system is significantly lowered.

This effect can be important to consider when making dynamic pressure measurements in liquid systems and when testing static pressures in a system using liquid filled lines for connection to a remote transducer. If vibration is present on liquid filled lines and transducers, unwanted oscillations can be added to the measurement. Sometimes small diameter orifices (restrictors) can be added to damp out these oscillations.

One method to predict performance of a transducer in these types of applications is to express the resonance frequency of the transducer/ liquid system in terms of the volumetric compliance of the transducer's force summing network.

Kulite oil filled pressure transducers are normally extremely reliable products. The metal isolation diaphragm along with the rugged silicon-sensing diaphragm together make for a very robust and durable product. However Kulite has come across situations where a seemingly benign application can

lead to unexpected failures. Kulite transducers are often used for measuring fuel pressures after the fuel boost pump in gas turbine engines. In some of these applications Kulite has received units that fail due to gold wire lead breaking and deformation/ cracking of the isolation diaphragm. Gold wire breakage is a very unusual condition because the gold wires have a very high natural frequency, which is well outside the engine vibration spectrum.

Under static pressure conditions the isolation diaphragm does not deflect as pressure is applied, and the silicone oil in the pressure capsule transmits the pressure with no relative movement. However a research program within Kulite has demonstrated that very fast, large amplitude dynamic pressure signals can set up uneven pressure waves across the face of the diaphragm due to cavity resonances within the transducer pressure port and pipework. This may cause the isolation diaphragm to be subjected to alternating compressive and tensile stresses, due to transient surface tension effects, which can eventually lead to a fatigue failure of the isolation diaphragm. Additionally, the motion of the isolation diaphragm can cause the silicone oil to flow rapidly back and forth and stress the gold wires, eventually causing fatigue fracture of the wires.

Finally, there is a phenomenon which occurs in a liquid when a rapidly moving pressure wave is stopped and generates a pressure spike which can be well in excess of the steady state pressure. This phenomenon is commonly referred to as “water hammer”. The pressure wave can be generated by any rapid change in a liquid filled system, such as valves closing. The pressure spikes which occur can have a large enough magnitude to damage the pressure transducer, associated components and pipework. Laboratory testing at Kulite have demonstrated pressure spikes in excess of 2000psi in a system with a static pressure of only 275psi.

In order to protect a pressure transducer from water hammer, a filter can be installed on the front of the pressure fitting. Several tests have been performed with both isolated design and leadless sensors and a variety of filter sizes. The addition of a filter decreases the response time of the transducer to a pressure wave and all of the tested filters completely blocked the water hammer effect. The filter is selected to attenuate the pressure spike to a safe level whilst retaining sufficient response time for the measurement or control function. The table below gives some examples of filter pore sizes and response times

<b>FILTER SIZE</b>	<b>THICKNESS</b>	<b>RESPONSE TIME</b>
10 Micron	.031”	23.95 milliseconds
20 Micron	.031”	10.15 milliseconds
40 Micron	.039”	3.36 milliseconds
100 Microns	.062”	2.08 milliseconds

References to technical papers on this subject are given in section 9.3.4 and describe in more detail techniques which can be used to reduce the frequency of the cavity/ pipe resonant systems and attenuate pressure spikes.

**5.5.4. Dynamic Pressure Measurements at High Temperatures**

Kulite pressure transducers are being used to measure dynamic pressures at high temperatures in many areas of research and development, particularly within the gas turbine (aero and industrial), aerospace and automobile industries. Kulite’s SOI and leadless technologies has enabled silicon based pressure transducers to operate at temperature in excess of 540°C (1000°F). Technical papers which have been published in this area are referred to in sections 9.3.7 & 9.3.8.

Despite the capability of the latest Kulite piezoresistive pressure transducers which are mounted on the casings of gas turbines to withstand temperatures in excess of 540°C (1000°F), there are regions of a gas turbine where dynamic gas path pressures are required to be measured which are hotter i.e. a

modern high pressure compressor outlet temperature typically exceeds 650°C (1200°F) and the gas temperature in the high pressure turbine can exceed 1400°C (2550°F). In these ultra high temperature environments the preferred way of measuring these small dynamic pressures reliably is to use either a flush-diaphragm transducer mounted in a water or air cooled jacket, which requires the supply of cool water or air and, although very effective, may be impractical, or the use of a non-resonant semi-infinite tube (SIT) system which removes the pressure transducer from the very hot environment by a distance of up to 1 metre. The diagram below is a schematic representation of an SIT system.

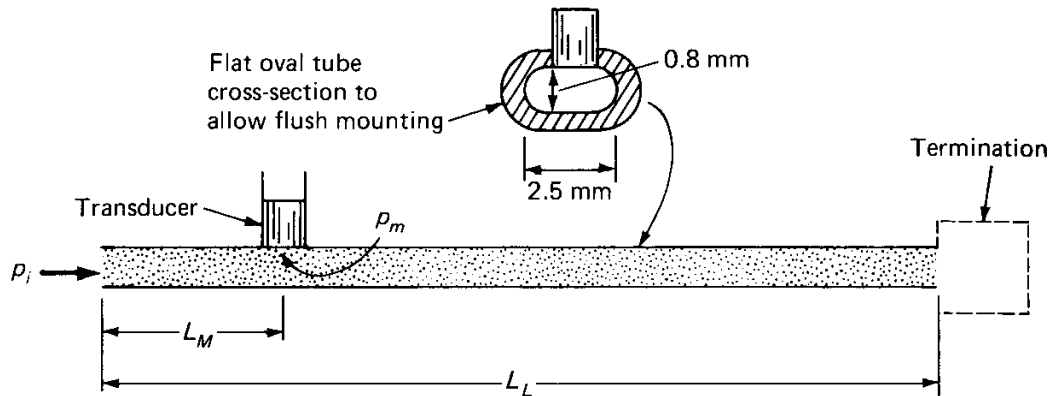

Figure 5-8: Diagram of a SIT Dynamic Pressure Measuring System

$L_M$  is typically 3 feet maximum and  $L_L$  is 18 feet minimum.

The theory behind the SIT design is that for a sufficiently long tube (semi-infinite), pressure fluctuations at the measuring station will have attenuated to small enough values at the far end that their reflection back to the measuring station will be very small, giving negligible measurement errors. The system does not possess a measurable resonant frequency. The far end termination is usually a closed end to the pipe. Alternatively a low response pressure transducer can be fitted to measure the static pressure value. Such SIT systems are capable of measurement bandwidths of many kHz but require precision manufacture, minimum discontinuity at the transducer matching position, no steps or discontinuities in the bore of the pipe and sufficient length of backing tube for the test conditions. Olsen [“Acoustic Engineering”, 1957] describes the use of non-resonant dynamic pressure measurement systems and gives a simple equation to calculate the attenuation against frequency characteristics of the tube to the transducer. Since the system is particularly prone to resonance problems caused either by manufacturing defects or lack of care when handling/installing the system, it is usual to calibrate the system and not rely upon the theoretical predictions used for design.